

INNOVATION & TECHNOLOGY

GRAUPNER

14+

WARNING:
CHOKING HAZARD – Small parts.
Not for Children under 3 years.
For Age 3 & up.



Manual

English

Receiver GR-8 HoTT No.33504



2014/06/30

Contents

Preamble	3
Approved Usage	3
Key to the Symbols	3
Safety notes	4
Box contents.....	4
What is HoTT?	5
Receiver Specifications	5
Method for Installation of Receiver.....	5
Binding and Range Test.....	6
Port information.....	7
GR-8 Receiver menue in the Telemetry	8
Method for Connection of Transmission and Engine Model.....	9
Firmware update.....	10
Notice.....	11
Environmental protection notes	11
Notice.....	12
Notice.....	13
Manufacturer's declaration on behalf of GRAUPNER/SJ GmbH	14
Declaration of conformity	15
Warranty	16

Although the information provided in these instructions has been carefully scrutinized for viability, no form of liability can be accepted for errors, omissions or print errors. Graupner reserves the right to change the described hardware and software features at any time without prior notification.

Preamble

Thank you for purchasing a GR-8 HoTT 2.4GHz Receiver. Please read this manual before using the product to ensure proper product usage. This operating manual contains warnings and cautions for your protection and safety, and for prevention against accidents or damage to property. Keep the manual in a place where you can easily access it. If any problem occurs during the operation of this product, please refer to this operating manual, or make an inquiry to our retail Website mentioned below, Graupner Retail Store or Graupner Service Centre.

	<p>Attention!</p> <p>Prior to the installation and commissioning of the receiver be sure to read the instructions completely.</p>
---	---

Approved Usage

The receiver is intended exclusively for use in radio-controlled models. Any other usage is prohibited, and may result in damage to the receiver or model, and serious personal injury. We grant no guarantee and accept no liability for any type of use outside the stipulated range. Not suitable for children under fourteen years. This receiver is not a toy!

The receiver is also equipped with a telemetry function which is only available in combination with a Graupner/SJ HoTT 2.4 system. If you do not own a Graupner/SJ HoTT 2.4 system, the receiver will not work.

Please start by reading through the whole instructions before you attempt to install and operate the receiver.



These operating instructions are an integral part of the product. They contain important notes on operating and handling the receiver. For this reason please store the operating instructions in a safe place, and pass them on to the new owner if you ever dispose of the product. Failure to observe the operating instructions and safety notes invalidates the guarantee.

Here at Graupner we are constantly working on the further development of all our products; for this reason we are obliged to reserve the right to introduce changes to the set contents in form, technology and features.

Please understand that we will not countenance claims resulting from information and illustrations in these operating instructions.

Please store the operating instructions in a safe place for future reference!

Key to the Symbols

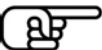
	<p>Caution!</p> <p>This symbol alerts you to prohibited actions which must be observed at all times. Any failure to observe the prohibited action indicated in this way may prevent the equipment working, and endanger the safety of the operator.</p>
	<p>Caution!</p> <p>This symbol alerts you to information which must be observed at all times. Any failure to observe the information indicated in this way may prevent the equipment working properly, and endanger the safety of the operator.</p>
	<p>This symbol indicates information which should always be observed in order to ensure that the equipment operates reliably.</p>

Safety notes

	Warning! The operation of the receiver under the influence of medication, alcohol, drugs, etc. is prohibited.
	Caution! Any deviation from the instructions may have an adverse effect on the function and operational security of the receiver, and must be avoided under all circumstances.
	Caution! The operator bears full responsibility for using the receiver. The only way to guard against personal injury and property damage is to handle the equipment carefully and use it exactly as recommended.
	Caution! Not suitable for children under fourteen years.
	Caution! Protect the receiver from dust, soiling, damp and foreign bodies. Never subject the receiver to excessive vibration, heat or cold.
	Caution! During the programming process you must bear in mind that an internal combustion engine or electric motor could unexpectedly burst into life at any time.
	Caution! Avoid subjecting the receiver to shocks and pressure. Check the receiver regularly for damage to the case and cables. Do not re-use a receiver which is damaged or has become wet, even after it has dried out again.
	Caution! When deploying the cables ensure that they are not under tension, not tightly bent (kinked) or fractured. Avoid sharp edges which could damage cable insulation.
	Caution! Ensure that all plug-in connections are firmly seated. Do not pull on the wires when disconnecting plugs and sockets.
	Caution! The receiver must not make physical contact with the model's fuselage, hull or chassis, as this would allow motor vibration and landing shocks to be transferred directly to it.
	Caution! It is not permissible to carry out modifications of any kind to the receiver. Any changes invalidate product approval, and you forfeit any insurance protection.
	Caution! Ensure that the equipment is working correctly and at full range before every flight. Check the state of the batteries at regular intervals.
	Note! Ensure that all your HoTT components are loaded with the current version of the software at all times.
	Note! Safety is no accident, and radio-controlled models are not playthings!

Box contents

1. GR-8 HoTT Receiver
2. Operating Manual

What is HoTT?

HoTT stands for HOPPING TELEMETRY TRANSMISSION. This is a next-generation Graupner communication technology—it prevents crossed frequencies by using 35 frequencies with optimized bidirectional HOPPING technology, and it enables excellent transmission and reception functions as well as telemetry communications across far distances; data such as RPM, voltage, current and warning of the product being used can be checked in real time by using 2.4GHz frequency band.

Receiver Specifications

Receiver GR-8:

Operating Voltage	3,6...8,4 V
Receiver frequency band	2,400...2,4835 MHz
Modulation	FHSS
Range	1000 m
Channel	4
Operating current	70 mA
Temperature range	-15 ... +70 °C
Antenna length	110 mm
Size	30 x 21 x 14,3 mm
Weight	6,9 g

Method for Installation of Receiver

The receiver is to be installed with a foam rubber cushion to afford protection against jarring, in aircraft models behind a strong rib and in a car or ship model in a place where it is protected against dust and spray water. The receiver may not be mounted in direct contact with the hull or chassis as this would allow motor vibrations and/or landing jolts to be transferred directly to the receiver. When a receiver system is installed in a model with a combustion motor, all receiver parts should be installed so as to prevent exhaust gases and oil residues from infiltrating. This especially applies to the ON/OFF switch, which is usually built into the model's outside skin. Position the receiver such that connecting cables to the servos and the power supply are routed with a bit of slack and that the receiver's antenna is at least 5 cm away from any large metal parts or wiring other than those proceeding from the receiver. In addition to steel, this also applies to carbon fiber parts, servos, electric motors, fuel pumps, any kind of cable and similar items. Optimally the receiver should be placed at a readily accessible location that is well away from all other equipment. Under no circumstances may a servo cable be wrapped around the antenna or routed close to it. Ensure that cables near the antenna cannot move about during flight.

Routing the receiver's antenna

The receiver and the antennas must be positioned as far away as possible from any drive components. If the model's hull is made of carbon fiber material, the ends of the antennas should always extend outside of the hull.

The orientation of antennas is not critical. Nevertheless, a vertical (upright) installation of the receiver's antenna(s) is advantageous.

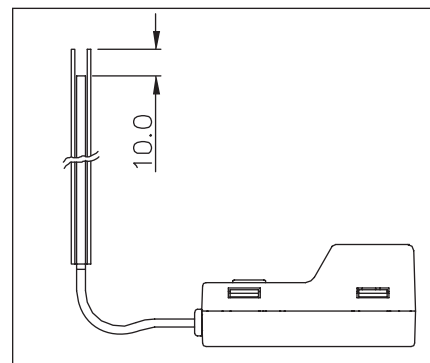

Binding and Range Test

Binding

Before any Graupner HoTT receiver can be used, it must first be "bound" to "its" Graupner HoTT transmitter to create a link, or connection; this procedure is known as "binding". However, binding is only necessary once for each combination of receiver / transmitter, and the process has already been carried out at the factory for the devices included in the set. This means that you only need to carry out the binding procedure if you purchase additional receivers (you can also repeat the procedure at any time, such as when you switch to a new transmitter). If and when you need to carry it out, this is the procedure:

Switch the receiver on, and switch it to Bind mode by holding the Binding button pressed in for three seconds: the green and red LEDs on the receiver now flash.

At the transmitter, select Binding in the "RF SET" menu by pressing the Enter button in the "Receiver" line. After about ten seconds the red receiver LED should go out; the green LED now lights up constantly to indicate that binding has been successful.

Your combination of transmitter and receiver is now ready to use.

However, if the red LED continues to show, then the binding procedure has failed. If this should happen, please repeat the whole procedure.

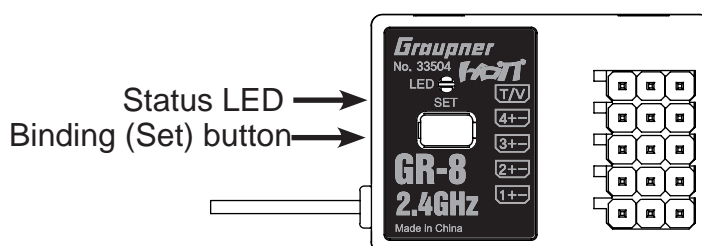

Range test

Perform checks for proper operation and range before any use. Secure the model adequately in place and ensure that no one is in front of the model. Perform a complete functional test on the ground and execute a complete simulated flight to rule out the possibility of system faults or problems with the model's programming.

You must refer to the instructions in the manual of the transmitter. Do not operate your model, ie when flying or driving, without transmitter or receiver antenna. Ensure a tight fit of the antenna.

Port information

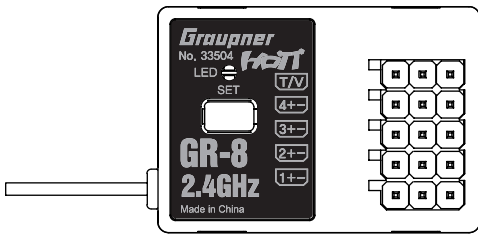

T/V
CH4
CH3
CH2
CH1

	red LED	green LED
not bound	flash	off
bound	off	on
error	flash	on
ready to bind	flash	flash

English

	Funktion	Alternativ	
CH 1	channel 1 signal out	SUMD-V2 BUS System	battery port
CH 2	channel 2 signal out	SUMD-V2 BUS System	battery port
CH 3	channel 3 signal out	SUMD-V2 BUS System	battery port
CH 4	channel 4 signal out	SUMD-V2 BUS System	battery port
T/V	ext.Temp./Voltage sensor	-----	

Port 1+2:

Connect PORT 1, 2 (Channel 1, 2 Terminal) to servo or transmission to use.

PORT 3+4: These channels are freely assignable control channels for special functions

Port T/V:

This connector is used to connect the optional external voltage and temperature sensor S8362. When the alarm threshold is reached, an alarm is output (set the alarm thresholds via the telemetry menu). You may connect the sensor and the voltage of a battery only after the following diagram:

Voltage, Temperature Sensor Structure - Order Number S8362

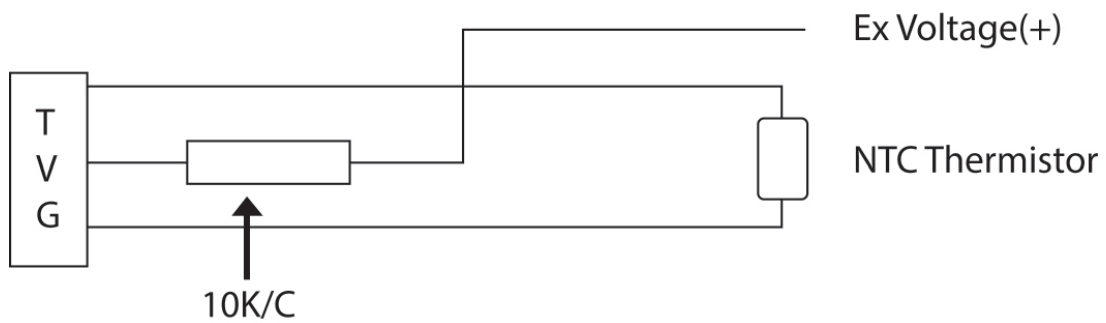

Ex Voltage(+) : (Enter power of transmission + Connect to terminal)

NTC Thermistor : (Install to engine head)



Caution: Do Not Connect a battery directly to this jack, this would destroy the receiver. This jack is also not suitable for the receiver power supply.

GR-8 Receiver menue in the Telemetry

```

RX DATA VIEW >
S-QUA : 100%
S-STR : 100%
S-dBm : -28dBm
RX-TEMP : +43 °C
LOSS PACK : 403MS
BATT VOLT : 4.9V
LOW VOLT : 4.9V
    
```

Display screen (display only)
S-QUA: transmitter quality
S-STR: transmitter strength
S-dBm: transmitter strength in dBm
RX-TEMP: receiver temperature
LOSS PACK: lost packages in milliseconds
BATT VOLT: receiver voltage
LOW VOLT: warning threshold for min. receiver voltage

```

RX SETUP V0.04 <>
>AL RX-V( 4.9V): 3.5V
AL RX-T( +43 °C): 64 °C
AL EX-V( 0.0V): AUTO
AL EX-T( -- °C): 10 °C
LANGUAGE :ENGLISH
    
```

Setting screen for warning thresholds, telemetry language
AL RX-V: warning threshold for receiver voltage
AL RX-T: warning threshold für receiver temperature
AL EX-V:warning threshold for ext. voltage sensor
AL EX-T: warning threshold for ext. temperature sensor
LANGUAGE: language selection (only telemetry menue)
 In parentheses, the current value is displayed

```

CH FUNCTION <>
>CH1 SUMD-V2 300US
CH2 SUMD-V2 300US
CH3 SUMD-V2 300US
CH4 SUMD-V2 300US

*FAST SIGNAL BUS 3.0M
    
```

Setting screen for channel properties
 (see chapter RF SET at X-8N)
CH1 - CH4 > Meaning of the settings:
 USR1m50 : ULTRA SIGNAL 1.5msec
 FSR3m00 : FAST SIGNAL 3.0msec
 SUMD-V2 : FAST SIGNAL BUS 3.0msec
 NSR6m00 : NORMAL SIGNAL 6.0msec
 NSR12m0 : NORMAL SIGNAL 12.0msec
 NSR24m0 : NORMAL SIGNAL 24.0msec

```

DEVICE LIST VIEW <>
No DEVICE CH PORT
>00 RECEIVER -- --
01 ----- -- --
02 ----- -- --
03 ----- -- --
04 ----- -- --
05 ----- -- --
    
```

Display of the connected components
 (display only, see chapter TELEMETRY at X-8N)

```

FAIL SAFE <>
>F/S MEMORY: NO
F/S DELAY : 50MS
CH1(STR):HOLD
CH2(THR): F/S 300US
CH3(AUX):HOLD
CH4(AUX):HOLD
    
```

Setting screen for fail safe
F/S MEMORY: Select to save the data in the receiver „Yes“ and press ENTER
F/S DELAY: fail safe delay
CH1(STR): FREE, HOLD, POSITION
CH2(TH): FREE, HOLD, POSITION
CH3(AUX): FREE, HOLD, POSITION
CH4(AUX): FREE, HOLD, POSITION
 (see also the description in chapter FAIL SAFE at X-8N)

Method for Connection of Transmission and Engine Model

English

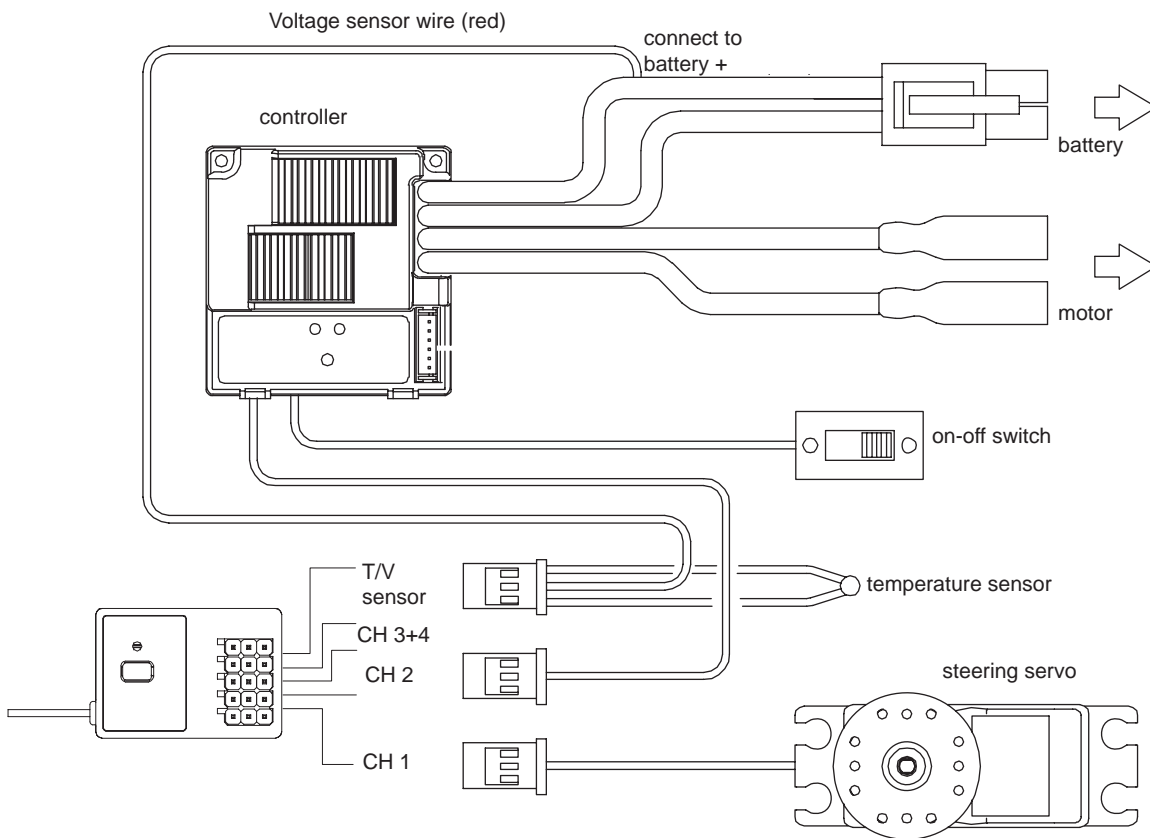

Example of connection for electric model

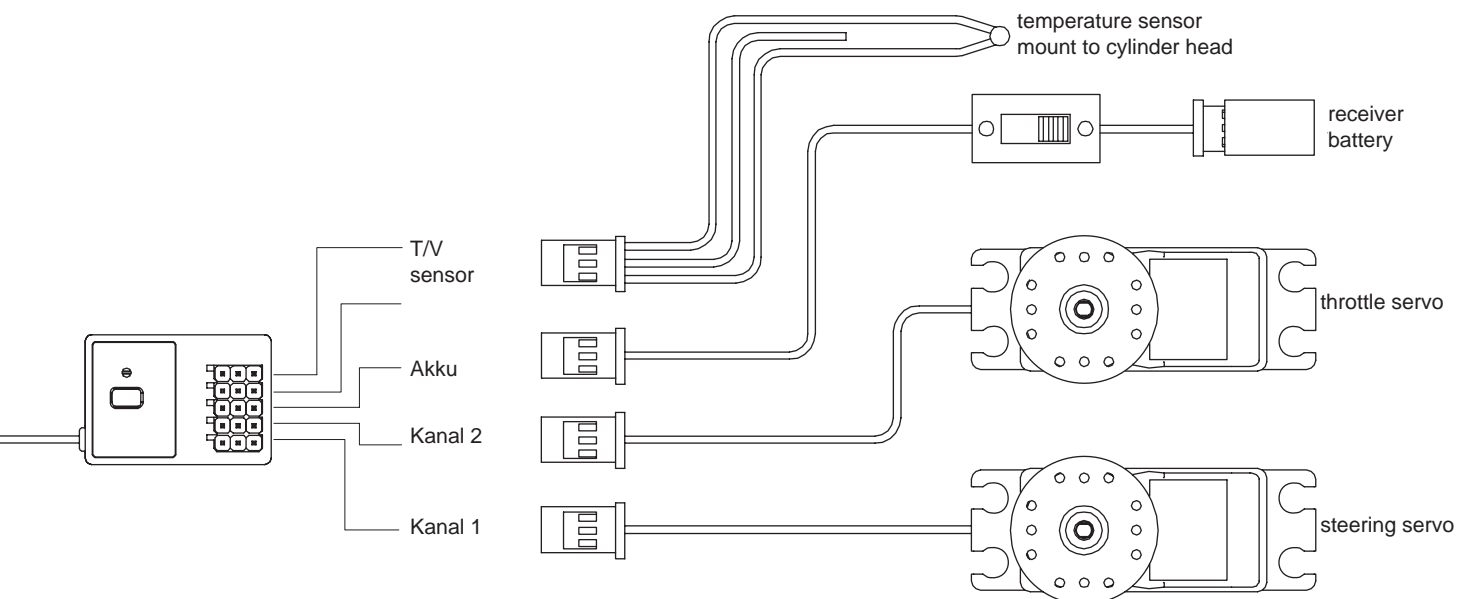

Example of connection for gas engine model

Firmware update

Firmware update Graupner GR-8 HoTT 2.4 receiver

Firmware updates for the receiver can be transferred via the DATA or telemetry interface in conjunction with a PC running Windows XP, Vista or 7. For this you also require the USB interface, Order No. 7168.6, and the adapter lead, Order No. 7168.6A or 7168.6S, which are available separately.

The programs and files required for this are available from www.graupner.de in the Download area for the corresponding products.

Install the Firmware Update Utility Graupner and the USB drivers on your computer. Check the system requirements!

English



Connect the adapter cable 7168.S to the USB port No. 7168.6. This socket is polarised; note the small chamfer on one edge. Never use force - the plug should engage easily and fully.

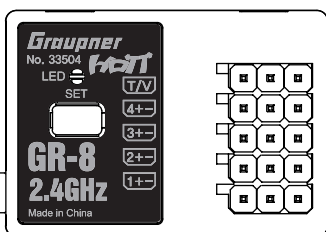

CH3> Connect the adapter lead to the Port CH3 socket. This socket is also polarised; note the small chamfer on one edge. Never use force - the plug should engage easily and fully.
The black wire (-) must be at the front, the white wire (T) at the back.

Update procedure

Ensure that the adapter lead is configured as shown in the illustrations, and is connected correctly to the receiver.

Start the Firmware Upgrade Graupner Studio.



Under „Port Select“ select the correct COM port „Silicon Labs CP210x USB to UART Bridge“, i.e. the one to which the USB lead is connected.

Choose the „HoTT device“ menu. Now click on the „File download“ button and select the the previously loaded firmware file ending in *.bin. If everything is correct, the file will appear in the corresponding window. Double-click the file to start the update process.

If you have not downloaded the file, press the button „Auto Download“. If your computer is connected to the Internet, he is now looking for the right software. If the firmware file is now displayed, press the button „File Download“ and the update process is started.

Please follow the detailed update instructions on <http://www.graupner.de> in the download section of the article or in the update and revision history on the home page of the website.

Notice



Contents of the manufacturer's declaration:

If material defects or manufacturing faults should arise in a product distributed by us in the Federal Republic of Germany and purchased by a consumer (§ 13 BGB), we, Graupner/SJ GmbH D-73230 Kirchheim/Teck, Germany, acknowledge the obligation to correct those defects within the limitations described below.

The consumer is not entitled to exploit this manufacturer's declaration if the failure in the usability of the product is due to natural wear, use under competition conditions, incompetent or improper use (including incorrect installation) or external influences.

This manufacturer's declaration does not affect the consumer's legal or contractual rights regarding defects arising from the purchase contract between the consumer and the vendor (dealer).

Extent of the guarantee

If a claim is made under guarantee, we undertake at our discretion to repair or replace the defective goods. We will not consider supplementary claims, especially for reimbursement of costs relating to the defect (e.g. installation / removal costs) and compensation for consequent damages unless they are allowed by statute. This does not affect claims based on legal regulations, especially according to product liability law.

Guarantee requirements

The purchaser is required to make the guarantee claim in writing, and must enclose original proof of purchase (e.g. invoice, receipt, delivery note) and this guarantee card. He must send the defective goods to us at his own cost, using the following address:

**Graupner/SJ GmbH, Service Department,
Henriettenstr.96, D 73230 Kirchheim/Teck, Germany
Service Department: tel. [0049] 7021-722130**

The purchaser should state the material defect or manufacturing fault, or the symptoms of the fault, in as accurate a manner as possible, so that we can check if our guarantee obligation is applicable. The goods are transported from the consumer to us and from us to the consumer at the risk of the consumer.

Duration of validity

This declaration only applies to claims made to us during the claim period as stated in this declaration. The claim period is 24 months from the date of purchase of the product by the consumer from a dealer in the Federal Republic of Germany (date of purchase). If a defect arises after the end of the claim period, or if the evidence or documents required according to this declaration in order to make the claim valid are not presented until after this period, then the consumer forfeits any rights or claims from this declaration.

Limitation by lapse of time

If we do not acknowledge the validity of a claim based on this declaration within the claim period, all claims based on this declaration are barred by the statute of limitations after six months from the time of implementation; however, this cannot occur before the end of the claim period.

Applicable law

This declaration, and the claims, rights and obligations arising from it, are based exclusively on the pertinent German Law, without the norms of international private law, and excluding UN retail law.

Declaration of conformity



**EU-Konformitätserklärung
EU-Declaration of Conformity**

Hiermit bestätigen wir, dass das nachfolgend bezeichnete Gerät den angegebenen Richtlinien entspricht.
We herwith confirm that the following appliance complies with the mentioned directives.

Artikelbezeichnung: GR-8 HoTT (Empfänger/Receiver)
Article description:

Artikelnummer: 33504
Article number:

Geräteklasse: 2
Equipment class:

Firmenanschrift: Graupner|SJ GmbH
Company adress: Henriettenstrasse 96
D-73230 Kirchheim/Teck

Einschlägige EU-Richtlinien / Governing EU-directives / Directives CE concernées :

- | | |
|---|---|
| <input checked="" type="checkbox"/> 1. Elektromagnetische Verträglichkeit (EMV)
Electromagnetic compatibility (EMC)
2004/108/EC | <input type="checkbox"/> 2. Niederspannungs-Richtlinie
Low-voltage directive
2006/95/EC |
| <input type="checkbox"/> 3. Maschinenrichtlinie
Mashine directive
2006/42/EC | <input type="checkbox"/> 4. Medizinprodukte (Klasse 1)
Medical device directive (Class 1)
93/42/EEC |
| <input checked="" type="checkbox"/> 5. Funkanlagen u. Telekommunikationseinrichtungen
Radio a. Telecommunication Terminal Equipment
R&TTE 1999/5/EC | <input type="checkbox"/> 6. Ökodesign-Richtlinie
Energy related products directive (ErP)
2009/125/EEC |
| <input checked="" type="checkbox"/> 7. Beschränkung der Verwendung bestimmter gefährlicher Stoffe in Elektro- und Elektronikgeräten
Restriction of the use of certain hazardous substances
2011/65/EC | |

Harmonisierte EN-Normen / Harmonised EN-Standards

Der Artikel entspricht folgenden, zur Erlangung des CE-Zeichens erforderlichen Normen:
The article complies with the standards as mentioned below which are necessary to obtain the CE-symbol:

Zu 1:
EN 301 489-1 V1.9.2
EN 301 489-17 V2.1.1

Zu 5:
EN 300 328 V1.7.1

Zu 7:
EN 60950-1:2006 + A11:2009 + A1:2010 + A12:2011
EN 62479:2010

Unterschrift / Signature

Position

Geschäftsführer / Managing Director

Ausstellungsdatum / Date of issue

16.04.2014



Graupner GR-8 Receiver
KCC Certification Number: MSIP-CRM-sjr-16005700
- Korea Communications Commission Notification 2013-01
- Korea Communications Commission Notification 2012-102
"Wireless devices that can be set up without reporting"



#33504: GR-8 Receiver
FCC ID: SNL-16005700

English

Wir gewähren auf dieses Erzeugnis eine / This product is / Sur ce produit nous accordons une

Garantie von **24** Monaten
warrantied for **24** months
garantie de **24** mois

Die Fa.Graupner/SJ GmbH, Henriettenstrasse 96, 73230 Kirchheim/Teck gewährt ab dem Kaufdatum auf dieses Produkt eine Garantie von 24 Monaten. Die Garantie gilt nur für die bereits beim Kauf des Produktes vorhandenen Material- oder Funktionsmängel. Schäden, die auf Abnutzung, Überlastung, falsches Zubehör oder unsachgemäße Behandlung zurückzuführen sind, sind von der Garantie ausgeschlossen. Die gesetzlichen Rechte und Gewährleistungsansprüche des Verbrauchers werden durch diese Garantie nicht berührt. Bitte überprüfen Sie vor einer Reklamation oder Rücksendung das Produkt genau auf Mängel, da wir Ihnen bei Mängelfreiheit die entstandenen Unkosten in Rechnung stellen müssen.

Graupner/SJ GmbH, Henriettenstrasse 96, 73230 Kirchheim/Teck, Germany guarantees this product for a period of 24 months from date of purchase. The guarantee applies only to such material or operational defects which are present at the time of purchase of the product. Damage due to wear, overloading, incompetent handling or the use of incorrect accessories is not covered by the guarantee. The user's legal rights and claims under guarantee are not affected by this guarantee. Please check the product carefully for defects before you are make a claim or send the item to us, since we are obliged to make a charge for our cost if the product is found to be free of faults.

La société Graupner/SJ GmbH, Henriettenstrasse 96, 73230 Kirchheim/Teck, Allemagne, accorde sur ce produit une garantie de 24 mois à partir de la date d'achat. La garantie prend effet uniquement sur les vices de fonctionnement et de matériel du produit acheté. Les dommages dus à de l'usure, à de la surcharge, à de mauvais accessoires ou à d'une application inadaptée, sont exclus de la garantie. Cette garantie ne remet pas en cause les droits et prétentions légaux du consommateur. Avant toute réclamation et tout retour du produit, veuillez s.v.p. contrôler et noter exactement les défauts ou vices, parce que nous sommes obligés de vous facturer nos frais, bien que le produit se trouve en bon état.

Garantie-Urkunde

Warranty certificate / Certificat de garantie

No.33504 / GR-8 HoTT

Übergabedatum
Date of purchase/delivery
Date de remise

Name des Käufers
Owner's name
Nom de l'acheteur

Straße, Wohnort
Complete address
Adresse complète

Servicestellen / Service / Service après-vente

<u>Graupner-Zentralservice</u>	<u>Servicehotline</u>
Graupner/SJ GmbH	☎ (+49) (0)7021/722-130
Henriettenstrasse 96	Montag - Donnerstag
D-73230 Kirchheim / Teck	7:30 -9:00 Uhr
	9:15 -16:00 Uhr
	Freitag
	9:00 - 13:00 Uhr

Die Adressen der Servicestellen außerhalb Deutschlands entnehmen Sie bitte unserer Webseite www.graupner.de.

For addresses of service points outside of Germany please refer to www.graupner.de/en/.

Pour adresses des points de service situés en dehors de l'Allemagne s'il vous plaît se référer à www.graupner.de/fr/.

Firmenstempel und Unterschrift des Einzelhändlers

Stamp and signature of dealer

Cachet et signature du vendeur